

Absolute Maximum Ratings		Values	Units
Symbol	Conditions ¹⁾		
Inverter			
V _{CES}		600	V
V _{GES}		± 20	V
I _C	T _{heatsink} = 25 / 80 °C	45 / 32	A
I _{CM}	t _p < 1 ms; T _{heatsink} = 25 / 80 °C	90 / 64	A
I _F = -I _C	T _{heatsink} = 25 / 80 °C	57 / 38	A
I _{FM} = -I _{CM}	t _p < 1 ms; T _{heatsink} = 25 / 80 °C	114 / 76	A
Bridge Rectifier			
V _{RRM}		800	V
I _D	T _{heatsink} = 80 °C	35	A
I _{FSM}	t _p = 10 ms; sin. 180 °, T _J = 25 °C	700	A
I ² t	t _p = 10 ms; sin. 180 °, T _J = 25 °C	2400	A ² s
T _J		- 40 ... + 150	°C
T _{stg}		- 40 ... + 125	°C
V _{isol}	AC, 1 min.	2500	V

MiniSKiiP 3 SEMIKRON integrated intelligent Power SKiiP 31 NAB 063 T1 3-phase bridge rectifier + braking chopper + 3-phase bridge inverter

Case M3

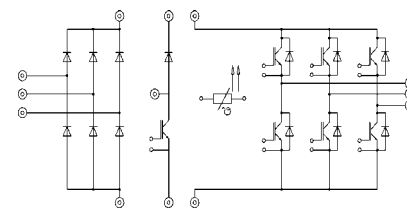

UL recognized file no. E63532

- fast NPT IGBTs

Characteristics		min.	typ.	max.	Units
Symbol	Conditions ¹⁾				
IGBT - Inverter & Chopper					
V _{CEsat}	I _C = 50 A T _J = 25 (125) °C	-	2,1(2,4)	2,6(2,9)	V
t _{d(on)}	V _{CC} = 300 V; V _{GE} = ± 15 V	-	45	-	ns
t _r	I _C = 30 A; T _J = 125 °C	-	35	-	ns
t _{d(off)}	R _{gon} = R _{goff} = 22 Ω	-	250	-	ns
t _f	inductive load	-	25	-	ns
E _{on} + E _{off}		-	2,65	-	mJ
C _{ies}	V _{CE} = 25 V; V _{GE} = 0 V, 1 MHz	-	2,8	-	nF
R _{thjh}	per IGBT	-	-	1,0	K/W
Diode ²⁾ - Inverter & Chopper					
V _F = V _{EC}	I _F = 50 A T _J = 25 (125) °C	-	1,45(1,4)	1,7(1,7)	V
V _{TO}	T _J = 125 °C	-	0,85	0,9	V
r _T	T _J = 125 °C	-	11	16	mΩ
I _{RRM}	I _F = 50 A, V _R = - 300 V	-	31	-	A
Q _{rr}	di _F /dt = - 800 A/μs	-	3,3	-	μC
E _{off}	V _{GE} = 0 V, T _J = 125 °C	-	0,36	-	mJ
R _{thjh}	per diode	-	-	1,2	K/W
Diode - Rectifier					
V _F	I _F = 35 A T _J = 25 °C	-	1,2	-	V
R _{thjh}	per diode	-	-	1,2	K/W
Temperature Sensor					
R _{TS}	T = 25 / 100 °C		1000 / 1670		Ω
Mechanical Data					
M ₁	Mounting torque	2	-	2,5	Nm
Case			M3		

¹⁾ T_{heatsink} = 25 °C, unless otherwise specified

²⁾ CAL = Controlled Axial Lifetime Technology (soft and fast recovery)

This technical information specifies semiconductor devices but promises no characteristics. No warranty or guarantee expressed or implied is made regarding delivery, performance or suitability.

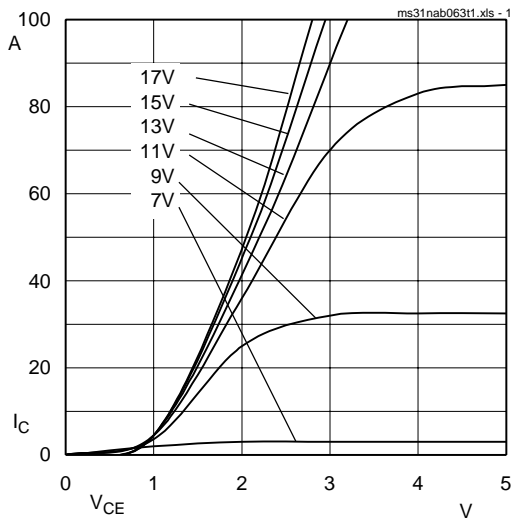

Fig. 1 Typ. output characteristic, $t_p = 80 \mu s$; $25^\circ C$

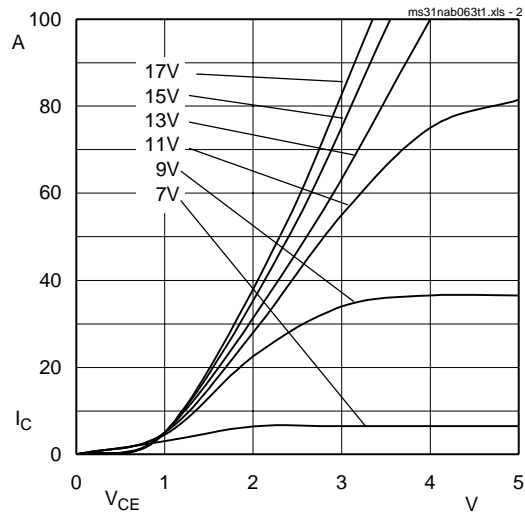

Fig. 2 Typ. output characteristic, $t_p = 80 \mu s$; $125^\circ C$

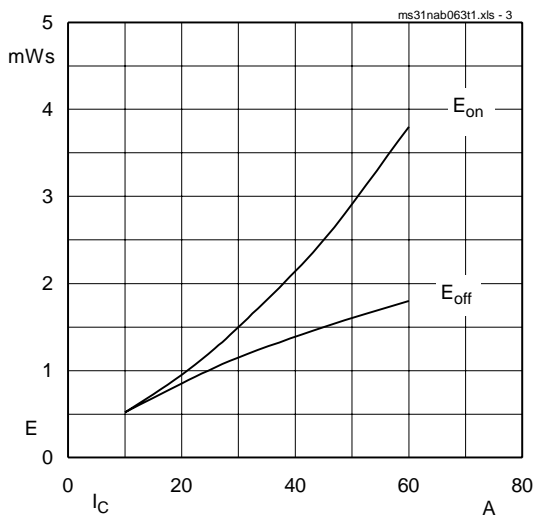

Fig. 3 Turn-on /-off energy = $f(I_c)$

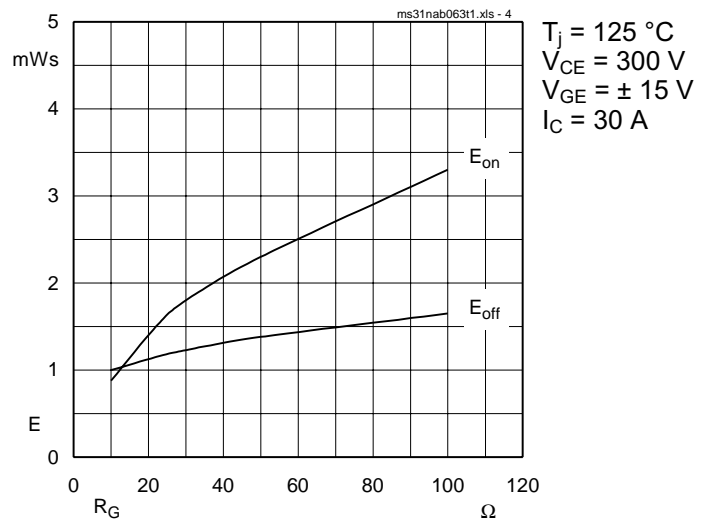

Fig. 4 Turn-on /-off energy = $f(R_G)$

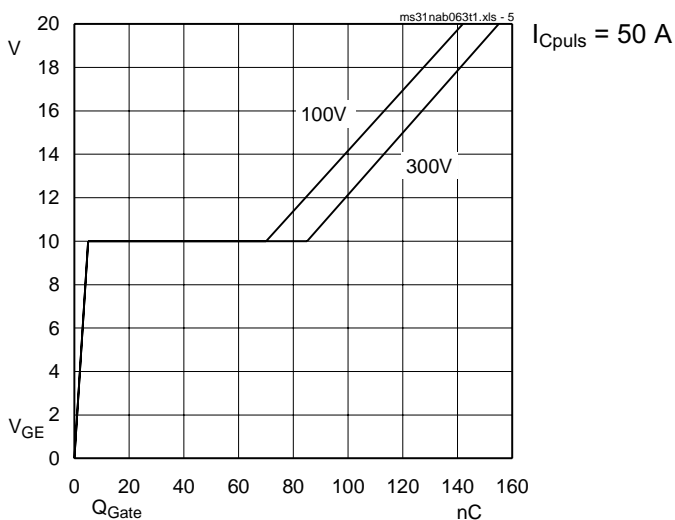

Fig. 5 Typ. gate charge characteristic

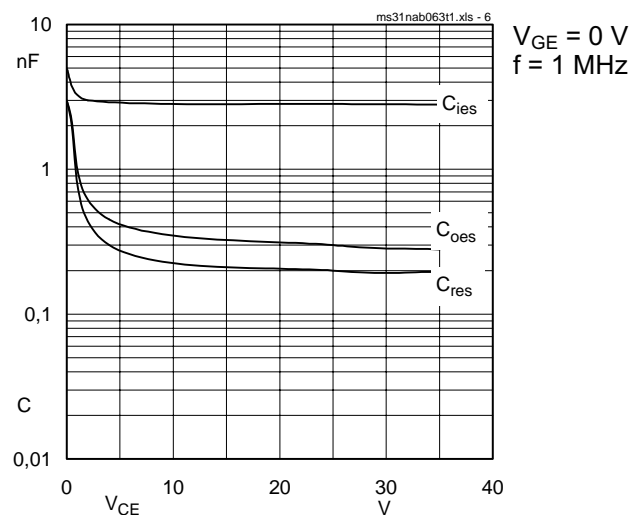

Fig. 6 Typ. capacitances vs. V_{CE}

2. Common characteristics of MiniSKiiP

MiniSKiiP 600 V

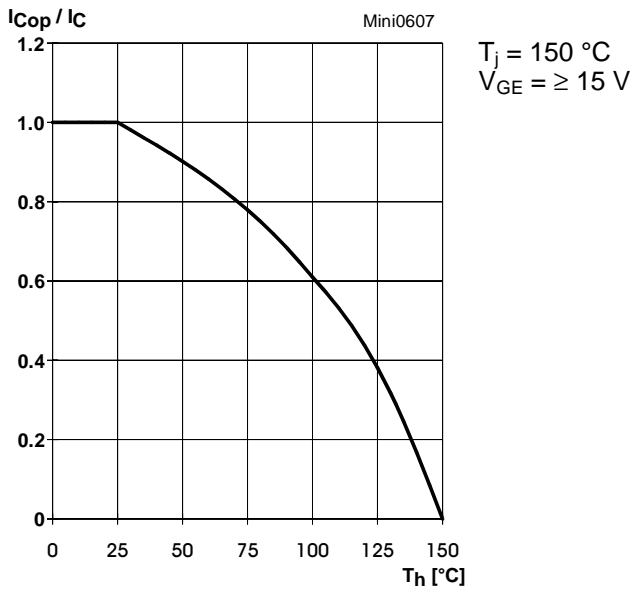

Fig. 7 Rated current of the IGBT $I_{COP} / I_C = f(T_h)$

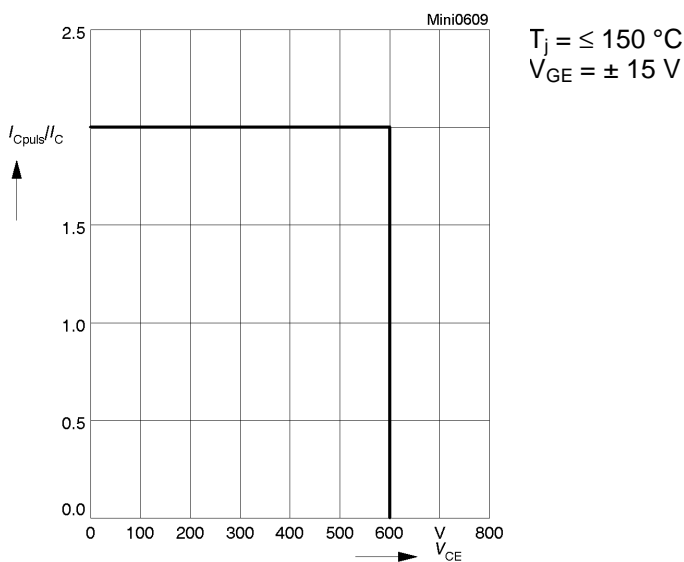

Fig. 9 Turn-off safe operating area (RBSOA) of the IGBT

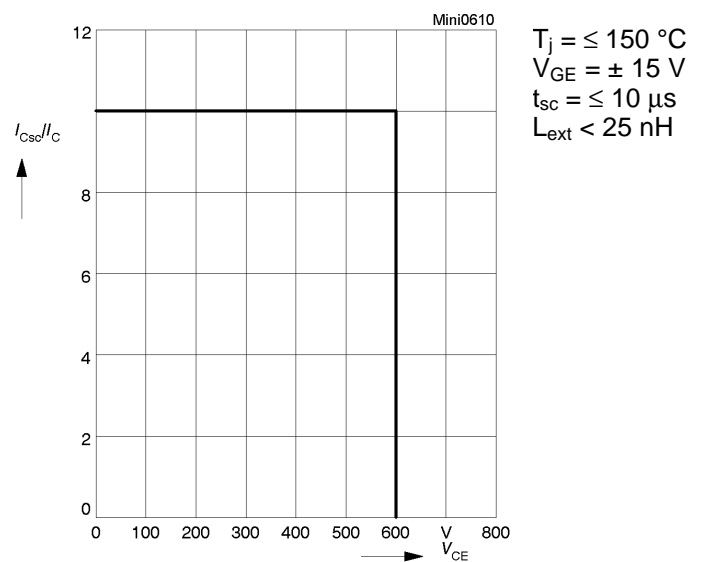

Fig. 10 Safe operating area at short circuit of the IGBT

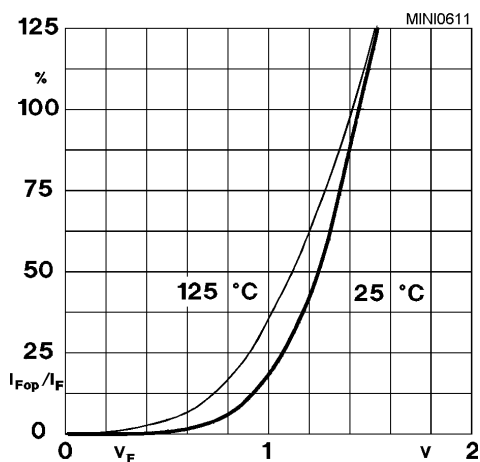

Fig. 11 Typ. freewheeling diode forward characteristic

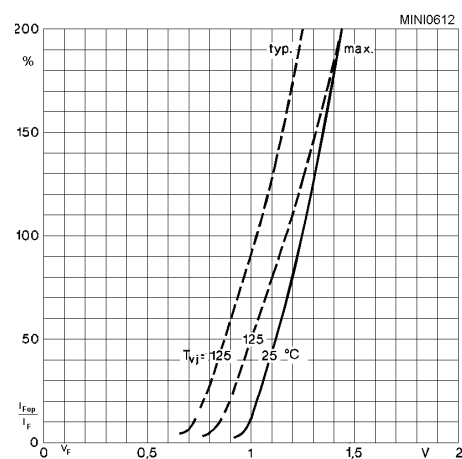
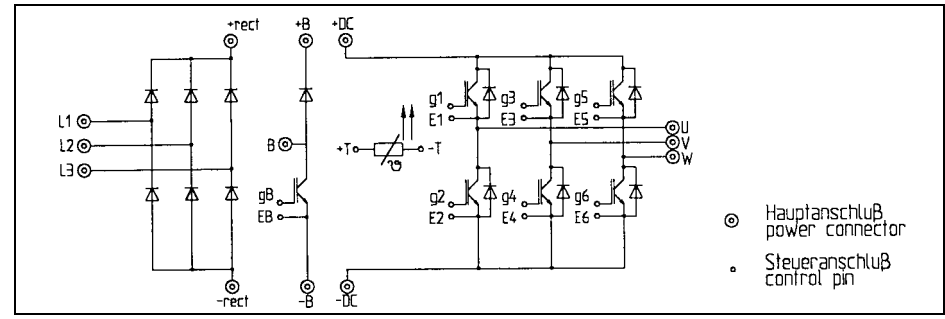

Fig. 12 Forward characteristic of the input bridge diode

MiniSKiiP 3

SKiiP 31 NAB 063 T1
SKiiP 32 NAB 063 T1



PCB

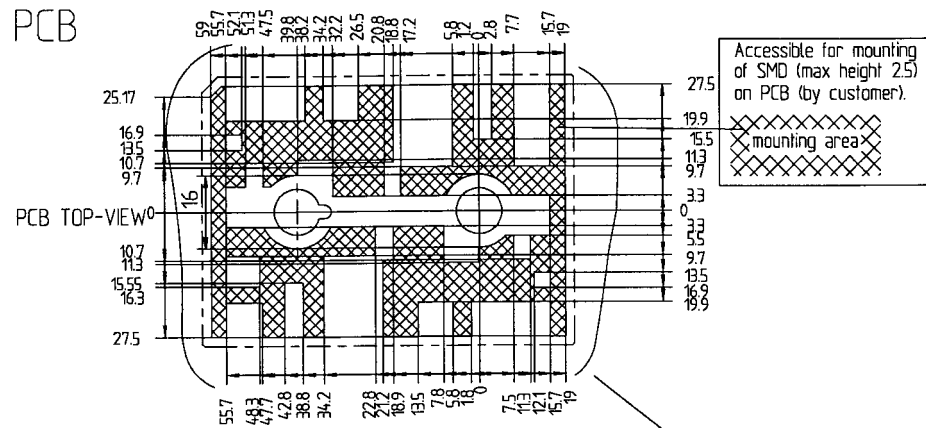

Mini-SKiiP 3

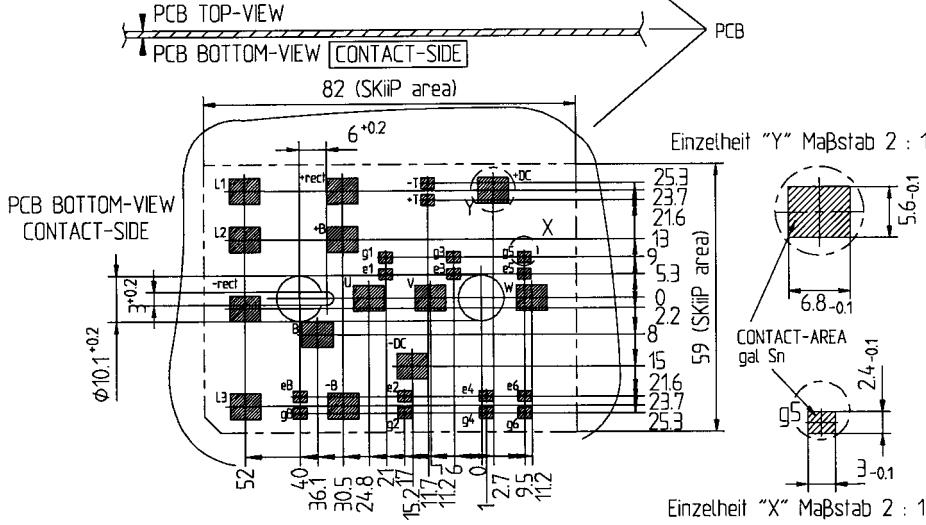
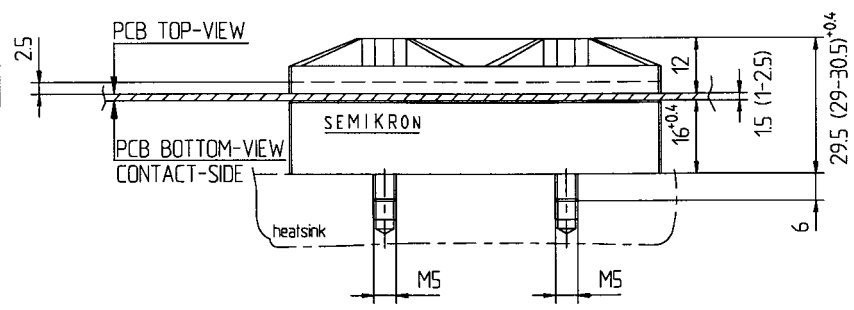

Bitte beachten Sie die Montagevorschrift

For mounting please follow the assembly instruction

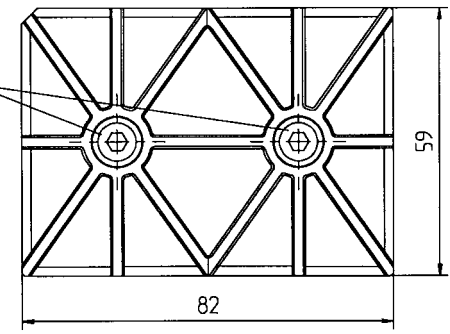

Tolerance: ISO 2768-f